

MARBELLA Outdoor Shower

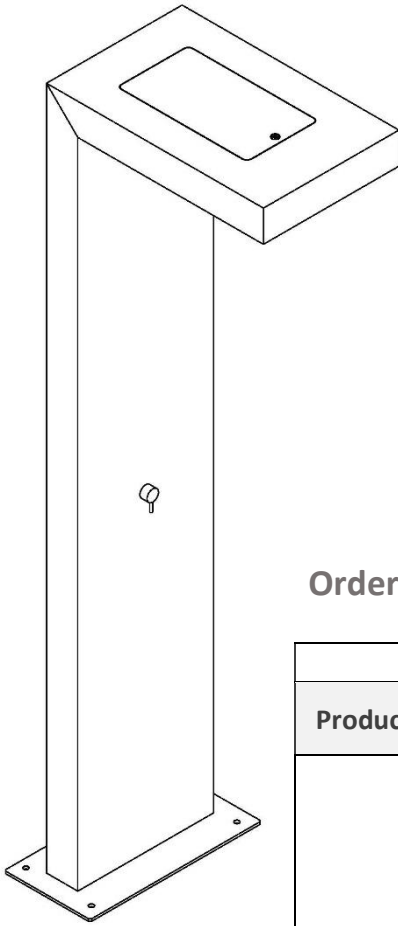

Ordering Information:

Product:	Material:	Standard Decors:*	Supply Direction:	Additional Features:						
MAR	K	P BHB SB R FB	BF SF	MS *	HC	LE	WT **	L	HS	PVD
	M	SN S SL GW GC C RF VA LI SB								

For Custom Decors check the Catalogue or contact your local sales representative.

For other custom requests, contact your local sales representative.

* On request if both cold and hot water are installed.

** Available for Ceramic material only.

ORDERING INFORMATION

Material

- ❖ **K**, collection made of natural stone *Kanfanar* (*other stone type on request)
- ❖ **M**, collection made of *The Marazzi* porcelain stoneware.

Standard Decors

Standard Decors available for **K** collection:

- ❖ **P** - Polished



- ❖ **BHB** - Bush Hammered & Brushed



- ❖ **SB** - Sandblasted & Brushed



- ❖ **R** - Rigato (Striped)



- ❖ **FB** - Flamed & Brushed

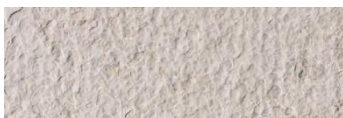

Standard Decors

Standard Decors available for **M** collection:

❖ **SN** - Sahara Noir



❖ **GW** - Golden White

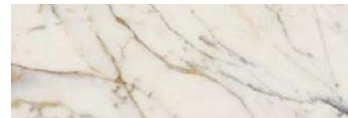

❖ **S** - Statuario



❖ **GC** - Grigio Carnico



❖ **SL** - Saint Laurent



❖ **C** - Corten



❖ **RF** - Rovere Francese



❖ **LI** - Limestone Ivory

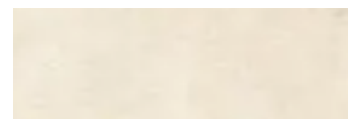

❖ **VA** - Verde Aver



❖ **SB** - Solidate Blu



Supply Direction

Two options for shower installation:

❖ Back Feed

- Preparation of underground supply installation required
- The required height of inlets and the type of fitting connections must be in accordance with the provided Installation Instructions

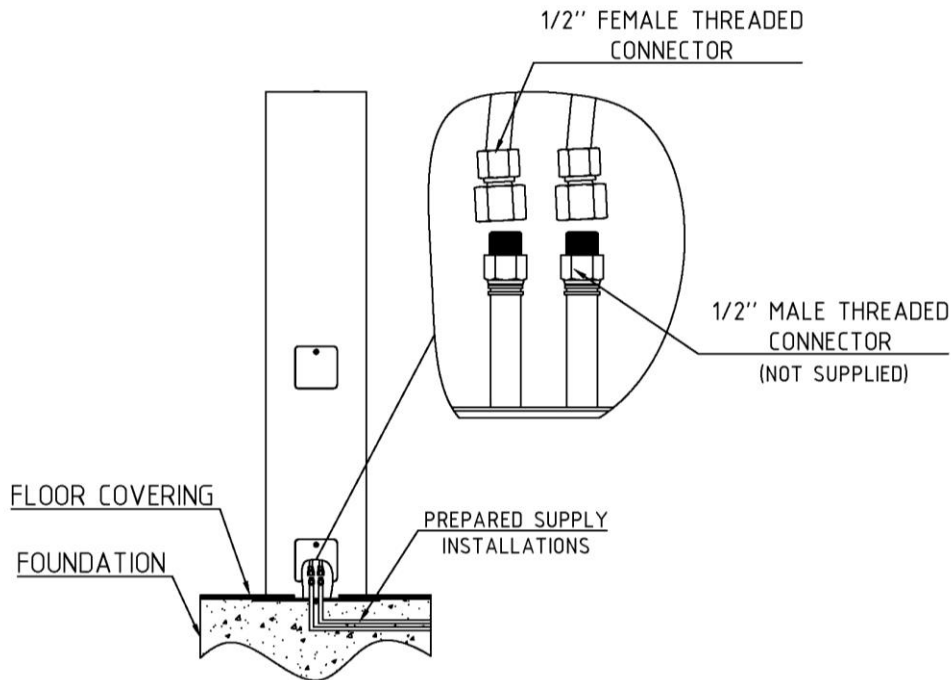

❖ Side Feed

- The connection is enabled outside the shower body
- No underground preparation is required
- Appropriate fittings must be provided at the supply ends

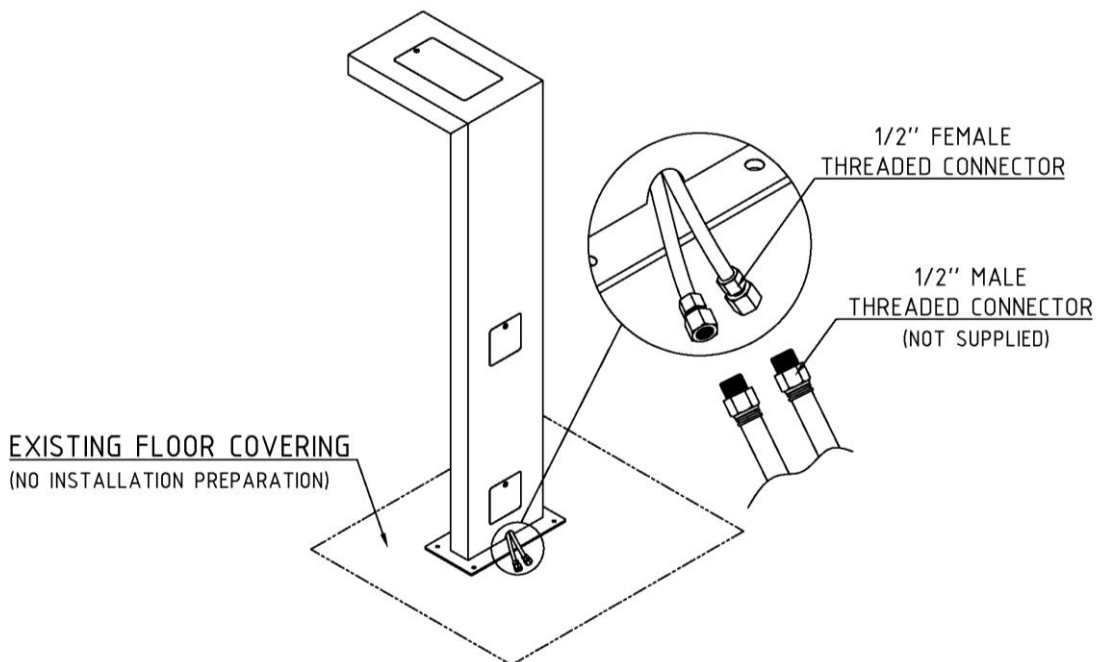

For more details, please refer to **Installation Instructions**.

Additional features

Each shower offers the following additional features:

- ❖ **MS** - Motion sensor*
- ❖ **HC** - Anti-frost heating cable
- ❖ **LE** - Logo engraving
- ❖ **WT** - Solar heated 15l / 4gal water tank**
- ❖ **L** - Ambient LED lighting designed by Filix
- ❖ **HS** – Hand shower
- ❖ **PVD** – (Physical Vapor Deposition) Shower handle coating

Available finishes:



SPECIFICATION FEATURES

Shower System

Consists of:

- ❖ 3 flexible stainless steel knitted hose ½”
- ❖ 2-way mixing mechanism with faucet and handle, showerhead
- ❖ The informed Nattura S shower catalyst with beneficial well-being effects

This basic system is subject to change depending on chosen additions.

Water Pressure

- ❖ Min = 2 bar ~ 29 PSI [lb/in²]
- ❖ Max = 4 bar ~ 58 PSI [lb/in²]

Operating Voltage

- ❖ 24V DC (If additional features are chosen)

Maintenance

Regularly clean with soft cloth.

Usage

- ❖ Outdoor

Warranty

3 years warranty regarding defects in material and shower system.

PRODUCT DIMENSIONS AND WEIGHT Stone

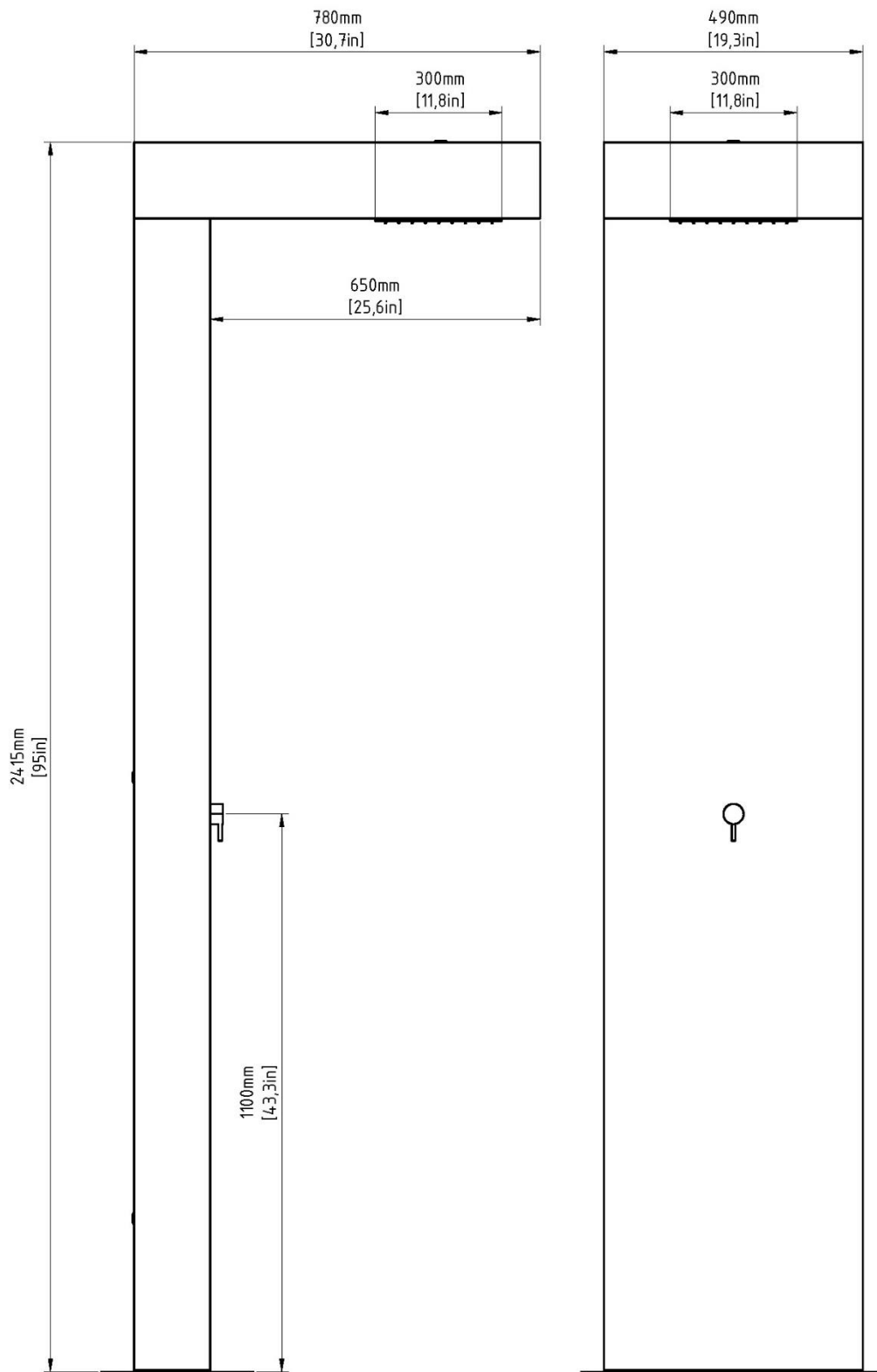

255kg / 562lbs

PRODUCT DIMENSIONS AND WEIGHT

Ceramic

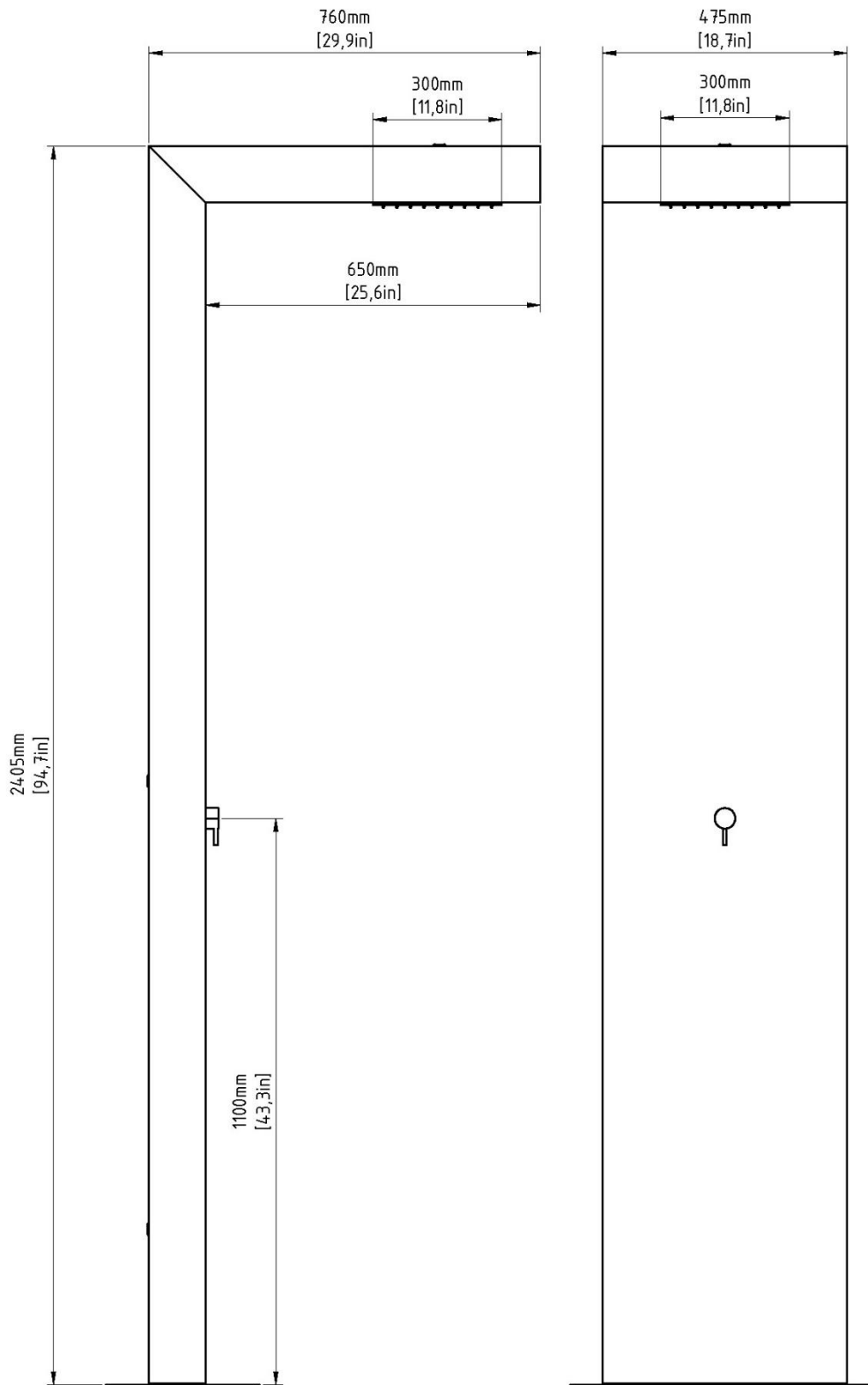

144 kg/318 lbs

PACKAGING INFORMATION

Delivery Box Dimensions and Weight for Stone Collection

❖ 2533 x 1068 x 740 mm ~ 100 x 42 x 29 in (Length x Width x Height)



288kg / 635lbs

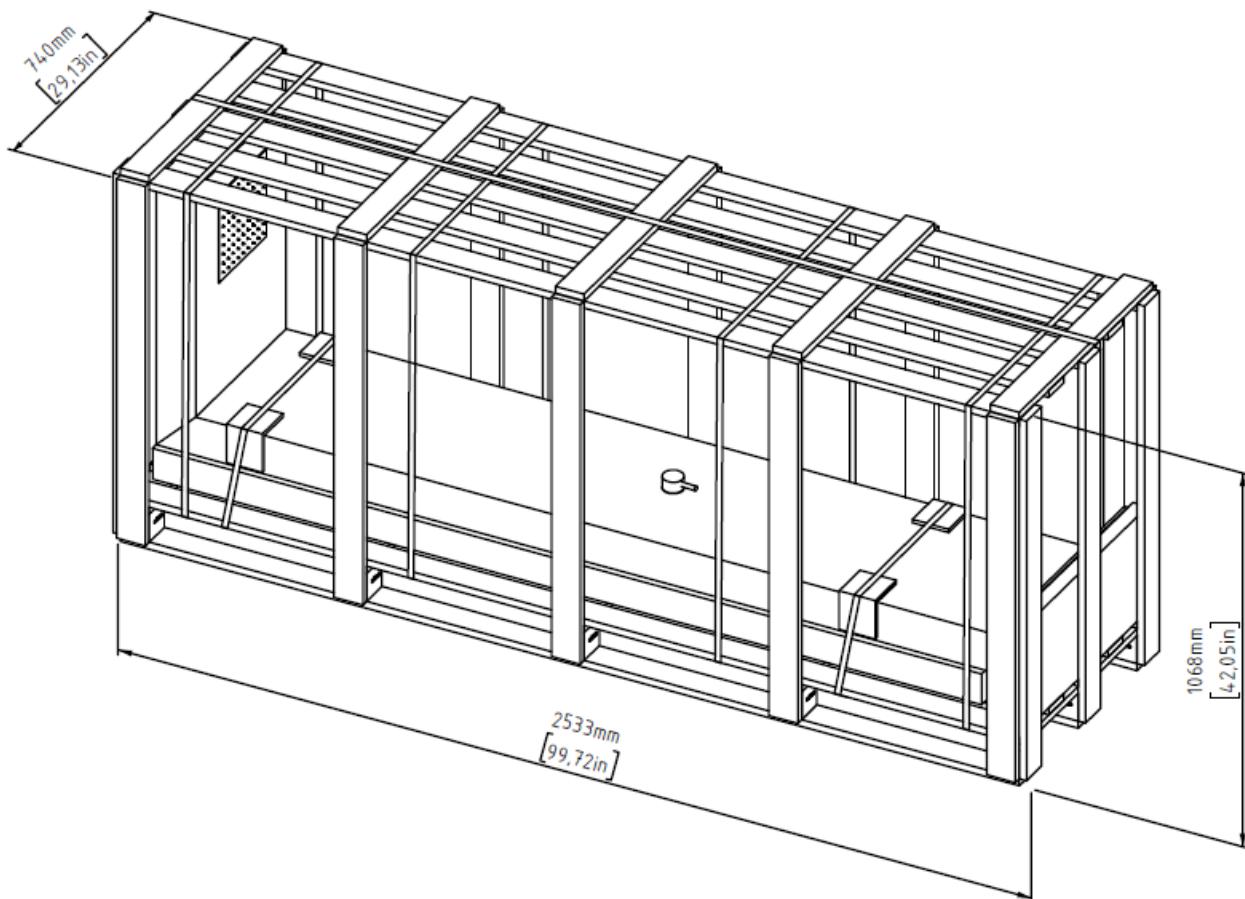

Delivery Box Dimensions and Weight for Ceramic Collection

❖ 2533 x 1068 x 740 mm ~ 100 x 42 x 29 in (Length x Width x Height)



177 kg/390 lbs

